

LOOSE LAY LVT INSTALLATION RECOMMENDATIONS

All instructions and recommendations are based on the most recent information available. They should be followed for an ideal installation. Visit our website at www.millikenfloors.com for the latest information and installation instructions. Contact Milliken Technical support if there are any specific concerns prior to installation. T: 01942 612 777

Milliken Loose Lay LVT is designed to be a “Loose Lay” installation, however proper preparation of the subfloor is still a major part of a successful installation. Roughness or unevenness of the subfloor may telegraph through the Milliken Loose Lay LVT overtime, resulting in an unsightly surface and cause excessive wear on high spots.

Loose Lay, allows quick and easy installation provided the resultant subfloor complies with the values stipulated in the relevant Building codes and Standards. All substrates must be properly prepared and tested according to the national guidelines as stated. Any installations incorporating subfloor underlayments / adhesives are solely underwritten by the individual manufacturer.

Handling and Acclimatisation

1. Store boxes flat, and neatly stacked. Do not store on end or sides, or allow to bend during storage or transportation.
2. Acclimatise all material and adhesive at site to 18° to 27°C for 24 - 48 hours prior to installation. For best results unbox and store as the diagrams. (First check batch and product details are correct).
3. Acclimatise the space to 18° to 27° C for 48 hours before during and after installation. The space should be enclosed with the permanent HVAC system operational prior to installation. After this installation period, avoid large sudden temperature changes and ensure a minimum 18C. Do not install outdoors.
4. Ensure the floor space will be permanently dry, clean, smooth, level, structurally sound, and free of all contaminants (e.g. dust, solvents, grease, chemicals, residual adhesive, adhesive removers, alkaline salts, mold, mildew etc.)
5. Loose Lay vinyl floors should not be exposed to direct sunlight for extended periods of time. Suitable window coverings are recommended in areas with high levels of direct sunlight exposure. A full-pattern of permanent adhesive is recommended in these areas of installation.
6. To prevent damage to the flooring the installation should be after all other trades have completed their work. If required, use a reinforced fibre-based temporary floor protector product.

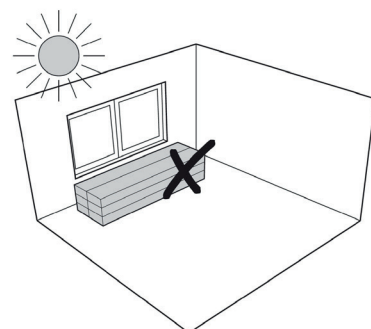
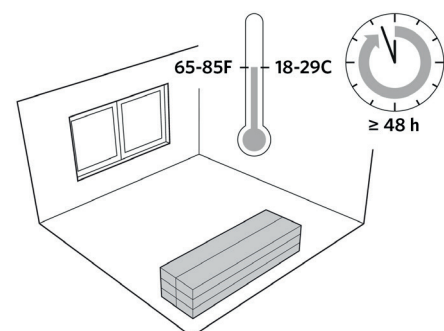
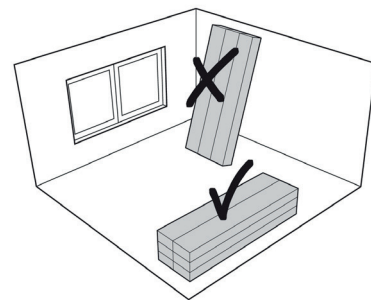

Floor Preparation and Installation

1. Ensure the installation area is well lit to enable proper inspection, and is clean and clear of debris that could potentially damage a finished plank installation.
2. Subfloor preparation must comply with up to date and relevant national code of practice for screeds, bases and in situ floorings e.g. AS/NZS 1884, ASTM F710, BS 8203, BS 8204, DIN 18365 (Teil C), DTU 53.2, or other applicable national Standards. Including max RH <75%, pH7 (for concrete floors).
3. Subfloor products used must be used in accordance with their manufacturer's instructions. Milliken accept no liability for their incorrect use. Ensure subfloor products are suitable for the type of traffic the area will be subjected to once installed.
4. All substrates must be smooth and flat to within 3 mm in 3 meters or achieve an "F50" rating by use of mechanical grinding/sanding or by applying suitable non-shrinking, water-resistant Portland based level/patch compound. Prepared according to the relevant country code of practice Installation and Preparation of Panel Type Underlayments to Receive Resilient Flooring.
5. The following are approved substrates for installation of Milliken Loose Lay LVT **when properly prepared for use with resilient flooring according to national codes and the above criteria are met.** Milliken will not cover or accept responsibility for joint telegraphing, either as a "ridge" or "valley"; grain or texture telegraphing; discolouration of finished flooring due to materials used for filling of voids and defects in the face of the underlayment. **Existing Linoleum or PVC floors must be removed prior to installation.**
 - **Raised Access Floor:** All panels to be level with no "Rocking movement". When installing Loose Lay LVT over raised access flooring, please ensure the following:
 - i. Panels are firm, level, smooth, dry and clean
 - ii. Lipping of panels must not exceed 0.75mm
 - iii. Height difference between panels must not exceed 0.75mm
 - iv. Gaps between panels must not exceed 1mm
 - v. Overall floor to be level within +/- 1.6mm

Milliken will not cover or accept responsibility for any joint telegraphing, either as a "ridge" or "valley.
- **SP 101 Plywood:** over structurally sound subfloor with minimal flexion
- **Concrete Subfloors:** moisture level does not exceed 75%RH in accordance with BS 8203
- **Cement Terrazzo, Epoxy terrazzo, ceramic & porcelain tile & marble**
- **Certain smooth metal floors:** (NOT Chequer plate) gaps patched with appropriate compound / leveler
- **Radiant Heated Floors:** where heat does not exceed 27°C and all other criteria are met, on all collections other than First Call, Open Shut & On Point
6. Adhesive residues from previous installations must be completely removed. Old adhesive residue - must be properly prepared with embossing leveler. Note: Solvents and other abrasive chemicals used to clean or remove subfloor contaminants can damage the backing.
7. Ensure that all boxes are of the same batch. Different lots should not be mixed in the same room as they may vary in colour, texture or gloss.
8. Install LVT according to the desired laying pattern. Minimise shade variation by mixing planks from different boxes throughout the installation.
9. Milliken Loose Lay LVT is to be installed using a full spread application of PSA / tackifier adhesive.
10. In areas of direct sunlight, e.g., floor to ceiling windows, a full spread of permanent adhesive must be used.

Floor Preparation and Installation (*continued*)

1. Release adhesives used must be acrylic based, and used according to their manufacturer's instructions. Milliken recommends **F. Ball Styccobond F40 & F41** and **Mapei Ultrabond Eco V4 Evolution**.
2. In the following areas a full spread of permanent adhesive should be used: Very Heavy Commercial applications or areas subjected to heavy traffic, excessive rolling loads, more volatile temperature variations, or if there are concerns with the subfloor conditions. Milliken recommend **F. Ball Styccobond F46** and **Mapei Ultrabond Eco VS90 Plus**.
3. Use a suitable "T" molding in doorways and archways to protect the exposed edges of the flooring. Use of a 25cm band of adhesive in all entryways is recommended to keep flooring from movement.
4. Any adhesive installed planks or tiles must be rolled with a 3 section 60-75Kg roller.

Layout and Cutting

Installation Methods

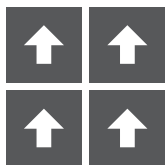

Monolithic

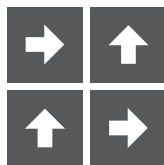

Quarter Turn

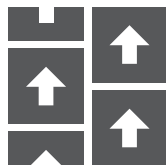

Half Drop / Ashlar



Plank: Parallel Random

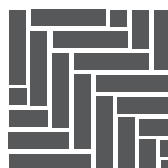

Plank: Herringbone

Milliken planks simulate wood, stone or abstract designs. It is recommended that First Call and Original Collection be installed Staggered Ashlar only. Change Agent can be installed in Staggered Ashlar or Herringbone. Rectangular tiles are best laid half drop. Square tiles can be laid monolithic, quarter turn or random.

Best appearance is usually achieved when laid parallel to the longest walls in the room. In spaces with direct sunlight sources, including large windows, doors, etc. install flooring perpendicular to the light source. Use of suitable window coverings during the times of most direct sunlight is recommended.

1. Determine the centre of the room and dry lay a section of tile/plank from the centre line to one wall to determine that the pattern is centred and fit. Measure the border cuts needed along the wall and ensure cuts will be at least 20cm long, and at least half plank wide (10cm). If necessary adjust the first row at the centre line to achieve this while maintaining the proper pattern. The tile/plank to be installed tightly together with a minimum 15cm or the width of the plank stagger to the next row.
2. Once the ideal centre position is determined from the dry layout, strike a parallel chalk line to the centre line of the length of the room approximately 60cm to 90cm from the wall.
3. Cut from the LVT face, using a tile cutter or a utility knife. Keep knife blades sharp for easy, accurate and safe cuts. Use appropriate safety gloves for protection. Fit planks to walls, columns, door jambs, etc. using the same methods as with other floor tiles; overlap, pattern scribe, wall scribe and free hand keeping a 3mm gap along all vertical surfaces.
4. When working on top of Loose Lay LVT during the installation, be sure to not disturb tiles and planks that have already been laid. If a piece does become dislodged simply peel it up and reinstall; use of a scrap piece as a tapping block can help readjust disturbed tiles and planks.

Adhesive Selection and Application Method

1. Milliken recommended adhesives are designed for use on most interior installations over most properly prepared and leveled, concrete, metal and wood substrates. Use of a non-Milliken recommended adhesive does not affect Milliken LVT product warranties, however, any claim related to adhesive performance or workmanship and any damage caused by this would be the total responsibility of the party responsible for using the non-recommended product.
2. For some commercial applications a heavy duty adhesive is recommended for a permanent bond. Typical applications for these types of adhesives are wet areas, floors subjected to heavy point loads and/or rolling loads, and floors that will be exposed to extreme temperature changes or extreme temperatures.
3. Apply a full spread of adhesive using a short nap paint roller, notched trowel in accordance with manufacturer's recommendations and application rates.
4. Take care not to allow adhesive to penetrate raised access flooring joints - it is good practice to stay 25mm away from panel joints.
5. Follow adhesive manufacturer's recommendations. Typically, adhesive is spread using a notched trowel.
6. Install consecutive rows by following the pattern and tightly butting all joints together. A scrap piece of flooring can be used to lightly tap the pieces into the previous row.
7. Be sure to stagger all end joints by at least 15cm or the width of one plank. Vary the length of your planks during installation to ensure that end joints are not bunched and a randomness is achieved in the pattern. Rotate some planks by 180° to enhance the random effect of the design.
8. During installation, once the adhesive has fully set, roll the areas of the floor that are utilising adhesive with a 3-section 60 - 75kg roller.

After Installation

1. Be sure planks are set, flat and have tight edges. Re-roll the entire installation along the perimeter and any area where adhesive is used with a 3-section 60-75kg roller to ensure all planks are properly set into the adhesive. If necessary, weigh down any loose planks overnight to ensure bond.
2. Clean adhesive residue from the face of the flooring following these directions:
 - Wet adhesive residue can be cleaned from the surface with a clean, white cloth dampened with warm, soapy water. Do not use excess water as this can seep between the seams of planks and lead to an adhesion failure!
 - Dry adhesive residue can be cleaned with mineral spirits or denatured alcohol and a clean cloth in a sparingly manner. Carefully follow the directions on the mineral spirits container. Do not pour soapy water, mineral spirits or denatured alcohol directly on the Milliken Luxury Vinyl Flooring.
 - Improper use of any chemical can harm the finish of the Milliken Luxury Vinyl Flooring product.
 - If working with epoxy or urethane adhesives you must clean these up while wet according to the adhesive manufacturer's instructions, which can be generally found on the container label.
3. In the event that the Milliken LVT is not the last portion of the construction project, the floor must be protected from construction traffic and damage. Wait 24 hours and utilise a reinforced fibre protective board or a heavy Kraft paper and cover the floor. Failure to wait 24 hours before covering can impact adhesive curing.

Initial Maintenance

1. 24 hours after installation is completed, thoroughly clean the floor using a neutral pH cleaner. If necessary, a slow (175rpm) buffer can be utilised with a white, non-abrasive pad to remove heavier deposits.
2. Thoroughly damp mop the floor and allow to dry. Do not pour water on the floor.