

# LVT GLUEDOWN INSTALLATION INSTRUCTIONS

All instructions and recommendations are based on the most recent information available. They should be followed for an ideal installation. Visit our website at [www.millikenfloors.com](http://www.millikenfloors.com) for the latest information and installation instructions. Contact Milliken Technical support if there are any specific concerns prior to installation. T: 01942 612 777

Milliken Luxury Vinyl Tile is designed to be installed by direct glue to the floor substrate. For a quality installation follow the instructions carefully and use approved adhesives, and subfloor preparation materials and methods.

## Before you start:

**Order all tiles for the flooring project at the same time. Compatibility of tiles in repeat orders cannot be guaranteed and batches should not be mixed within one space.**

## Storage and Acclimatisation

1. Handle store and transport LVT carefully to avoid product distortions. Store and transport boxes of tile / plank on a flat surface, stacked neatly up to 5 high. Never store upright or on side. Do not allow boxes to bend during storage or transportation. Avoid exposure to extreme temperature or humidity conditions.
2. Acclimatise product to site conditions by delivering all materials, including adhesives and sub floor products, to the job site at least 48 hours prior to installation. Store all products at 18° to 29°C for 48 hours prior to installation.
3. The space where flooring is to be installed shall be fully enclosed with the permanent HVAC system operational prior to installing flooring. The temperature shall be 18° to 29°C for 48 hours before installation, during installation and for 48 hours after installation. The temperature of the space shall be kept at a minimum 10°C continually after installation.

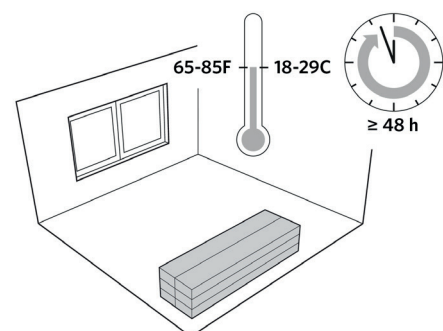
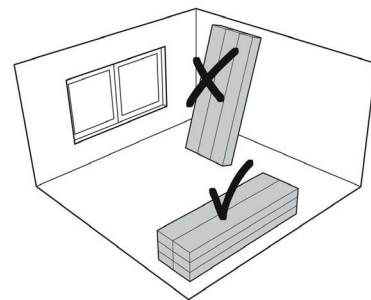

## Subfloor

To prevent adhesion problems, make sure that the subfloor is flat (no more than 4.5mm within 3 metres), smooth, clean (including free from fat, grease, chemical substances, mould, salts...), sound, stable and dry. The floor should be prepared in accordance with BS8203 or equivalent national standard.

The type of subfloor, its quality and its preparation will have a big influence on the final installation result. Subfloor defects will become visible through the LVT floor finish with time.

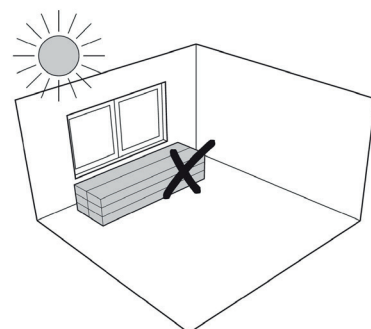

## Subfloor (continued)

Approved substrates, correctly prepared include:

- Cement, Marble, Terrazo, Ceramic
- Metal floor
- WPB 6mm Plyboard (exterior grade plyboard, sanded face with ratings APA A-B, A-C, B-B, B-C, C-C plugged face)
- APA registered exterior grade underlayment, sanded face (grades as above)

Alternative substrates should not be used as they may be prone to excessive movement during the life of the installation.

Any previously installed soft floorcovering and its debris should be removed before installation. (eg. Vinyl, carpet, linoleum, cork.)

### **WARNING:**

*DO NOT SAND, DRY SWEEP, BEAD BLAST, SHOT BLAST OR USE ANY OTHER MECHANICAL MEANS TO PULVERISE EXISTING TILE FLOORING, BACKING, LINING FELT, ASPHALTIC "CUT - BACK" OR ANY OTHER ADHESIVES. THESE PRODUCTS MAY CONTAIN ASBESTOS FIBRES AND /OR CRYSTALLINE SILICA. AVOID CREATING DUST. INHALATION OF SUCH DUST IS A CANCER AND RESPIRATORY TRACT HAZARD. SMOKING BY INDIVIDUALS EXPOSED TO ASBESTOS FIBRES GREATLY INCREASES THE RISK OF SERIOUS BODILY HARM. UNLESS POSITIVELY CERTAIN THAT THE PRODUCT IS A NON - ASBESTOS CONTAINING MATERIAL, YOU MUST PRESUME IT CONTAINS ASBESTOS. REGULATIONS MAY REQUIRE THAT THE MATERIAL BE TESTED TO DETERMINE ASBESTOS CONTENT.*

Floor should be flat within 4.5mm (3/16") or achieve F32 rating by use of mechanical sanding / grinding or recommended levelling / patching compound.

The moisture content of the subfloor must be less than 2.5% CM in case of cement screeds and less than 0.5% CM in case of anhydrite. If the moisture content is higher, an appropriate liquid damp proof layer can be applied, according to the manufacturer's instructions. Always measure, record and keep your test results. Sweep and vacuum to remove all debris before carrying out the test.

## Moisture Test

Moisture testing of all sub-floors is essential before installation can begin. This is true of new and old buildings. Moisture testing must be carried out and recorded. All moisture tests must be undertaken in accordance with BS 8203 (ASTM F1869 Calcium Chloride Test) (ASTM F2170 in-situ relative humidity test) and using an appropriate method to suit the sub-floor type. The sub-floor may be considered dry when the relative humidity is 75% Relative Humidity or below. If readings are above this level, a surface damp proof membrane can be applied. Consult manufacturers for instructions. Alternatively sub-floors can be given sufficient time to dry.

## Preparation by Floor Type

### **Ply board**

Raised access floors, timber floors etc can be made suitable using appropriate grade Plyboard (6mm WPB) to create a sound substrate.

Fix the board at 100mm intervals round the perimeter and, 150mm centres to the field. Smooth out board joints using feathering compound. Sweep, vacuum remove dust and debris.

### **Tile flooring**

If necessary, use a levelling compound to level all joints between the tiles. Preferably apply a second levelling compound.

## All flooring

Primary, Levelling and Sanding – All Flooring

It is necessary to apply a primer, to ensure the smoothing / levelling compound has a good adhesion to the subfloor. Use the recommended roll, following the instructions of the primer compound. Once dry, apply a smoothing / levelling compound with a thickness of 3-5 mm, with an appropriate trowel, according to the manufacturer's instruction.

Finish the application with a spike roller to avoid air inclusions. Respect the recommended drying time as indicated by the producer. Prior to the final glue application, sand the levelling layer as recommended and vacuum.

For any site specific concerns regarding sub-floor preparation and suitability for use with Milliken LVT please contact our sub-floor preparation partner Ardex for further detailed advice: [www.ardex.co.uk](http://www.ardex.co.uk) | Tel +44 (0) 1440 714 939

## Final check before installation

1. It is good practice to make a final check of the sub-floor for minor defects.
2. Make sure the planks are sufficiently mixed when you install them, so that you do not end up with too many identical, lighter or dark panels in the same area.
3. Check all tiles in daylight before and during installation. Defective pieces must never be used.
4. The floor should preferably be installed parallel to how the light enters the room.

## Installing Milliken LVT

The following installation methods should be used:

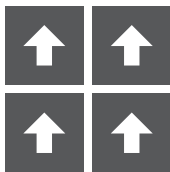

Monolithic

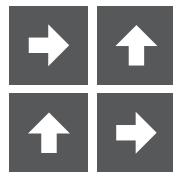

Quarter Turn

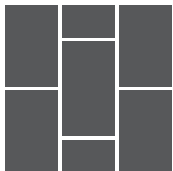

Half Drop



Plank

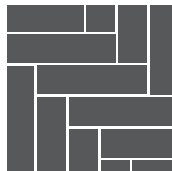

Herringbone

Milliken plank simulates wood planks, and can be installed in the same pattern as a wood plank floor in a random pattern, staggered design, diagonally, Herringbone or other design.

1. Measure the room and find the centre line. Starting the installation from the centre line ensures a straight and symmetrical installation. The floor should preferably be installed in a direction parallel to the direction that light enters the space.
2. If necessary you can shift the starting point to prevent any unnecessary small cuts. Milliken LVT can easily be cut with a cutter or utility knife. With the décor side face up find centre line.
3. Dry lay one plank/tile per row (without adhesive) from this centre line to the wall and ensure no small cuts are needed. Take away these planks.
4. Then start the installation from the centre line. Mix up the panels to become a nice pattern.
5. Dry lay the planks of 2 rows at a time. Cut the end planks to size ensuring an accurate cut. Milliken products can be cut using a tile cutter or a utility knife. Keep knife blades sharp for easy, accurate and safe cuts. Fit tiles to walls, columns, door jambs, etc. using the same methods other floor tiles; overlap, pattern scribe, wall scribe and free hand.
6. Now all panels of the rows are ready to be installed on the glue without unnecessary waiting time.
7. Pull back the rows of panels and apply Milliken's recommended adhesive to the floor using an A2 trowel to ensure correct application rate. It is strongly recommended to use the correct adhesive, and roll to ensure good transfer.

## Recommended Adhesives

**ARDEX AF-100** for general installation.

**ARDEX AF-2510** (2 part polyurethane adhesive) for areas of high exposure to direct sunlight, or prone to liquid spills.

### UZIN KE 66

High temperature adhesive for general installation.

### UZIN KE 2000 S

Pressure sensitive adhesive for general installation.

---

## After Installation

1. Be sure planks are set, flat and have tight edges.
2. Re-roll the entire installation, along the length and width of the planks with a 3-section 50Kg. roller to ensure all tiles are properly set into the adhesive. If necessary, weigh down any loose planks overnight to ensure bond.
3. Clean adhesive residue from the face of the flooring following these directions:
  - Wet adhesive residue: clean with white cloth dampened with warm, soapy water. Do not use excess water, this can seep between the seams of planks and lead to an adhesion failure.
  - Dry adhesive residue: clean with mineral spirits or denatured alcohol and a clean cloth. Use sparingly and in accordance with the directions on the mineral spirits container. Improper use of any chemical can harm the finish of the LVT. Do not pour mineral spirits or denatured alcohol directly on the LVT planks.
  - Epoxy or urethane adhesives: must be cleaned while wet according to the adhesive manufacturer's instructions.
4. In the event that the plank flooring is not the last portion of the construction project, the floor must be protected from construction traffic and damage. Wait 24 hours and utilise a reinforced fibre protective board or a heavy kraft paper (min. 30Kg.) and cover the floor. Failure to wait 24 hours before covering can impact adhesive curing.
5. Maintain your Milliken LVT installation following the Milliken LVT Maintenance Guide.